

# ST-D707

## SERVICE MANUAL

*AEP Model  
UK Model  
East European Model*

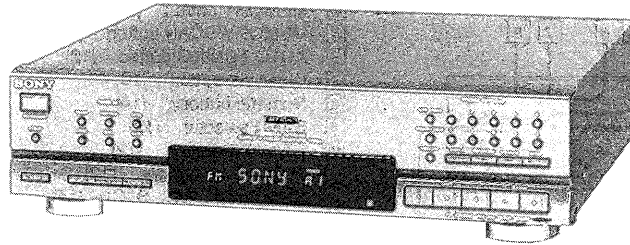

• This set is the TUNER section in LBT-D507/D607/D707.

### SPECIFICATIONS

System	FM stereo FM/AM superheterodyne tuner	Power requirements	240 V AC, 50/60 Hz
FM tuner section		Power consumption	10 W
Tuning range	87.5 to 108 MHz	AC outlet	2 switched, total 450 W max.
Antenna	75 ohms unbalanced	Weight	Approx. 2.7 kg (6 lbs 5 oz)
Intermediate frequency	10.7 MHz	Dimensions	Approx. 355 x 95 x 310 mm (14 x 3 <sup>3</sup> / <sub>4</sub> x 12 <sup>1</sup> / <sub>4</sub> inches) (w/h/d, including projections)
AM tuner section			
Tuning range	MW: 531 to 1,602 kHz LW: 153 to 279 kHz		
Antenna	AM loop antenna External antenna terminal		
Intermediate frequency	450 kHz		

Design and specifications are subject to change without notice.

#### Note

This appliance conforms with EEC Directive 87/308/EEC regarding interference suppression.

### MODEL IDENTIFICATION

— Model Number Portion —

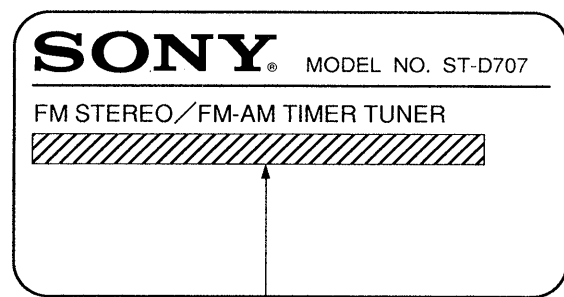

AEP, East European model : AC : 220—230V ~ 50/60Hz

UK model : AC : 240V ~ 50/60Hz



**FM STEREO/FM-AM TIMER TUNER**  
**SONY®**



# SECTION 1 GENERAL

This section is extracted  
from instruction manual.

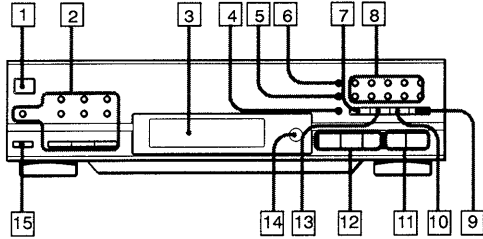
## Location of Controls



- 1 SYSTEM POWER switch (8)
- 2 Buttons for setting the clock and timer (40, 42)
- 3 Display window
- 4 MEMORY button (14)
- 5 MEMORY SCAN button (16)
- 6 AUTO TUNING button (12)
- 7 DISPLAY button (16, 40)
- 8 Numeric buttons (14)
- 9 BAND selector (12)
- 10 ST/MUTE button (12)
- 11 TUNING +/- buttons (12)
- 12 SHIFT buttons (A, B, C) (14)
- 13 CHARACTER button (15)
- 14 Remote sensor
- 15 SLEEP button (41)

**SAFETY-RELATED COMPONENT WARNING!!**  
 COMPONENTS IDENTIFIED BY MARK  OR DOTTED LINE WITH MARK  ON THE SCHEMATIC DIAGRAMS AND IN THE PARTS LIST ARE CRITICAL TO SAFE OPERATION. REPLACE THESE COMPONENTS WITH SONY PARTS WHOSE PART NUMBERS APPEAR AS SHOWN IN THIS MANUAL OR IN SUPPLEMENTS PUBLISHED BY SONY.

# SECTION 2 ELECTRICAL ADJUSTMENTS

## FM SECTION

SSG	Carrier frequency	98MHz
	Modulation	MONO : 1kHz, 40kHz deviation
		STEREO : Audio 1kHz, 16.25kHz deviation Pilot 19kHz, 7.5kHz deviation Sub-carrier 38kHz, 16.25kHz deviation

### • FM Discriminator Alignment (NULL check)

Setting :

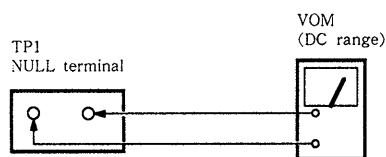
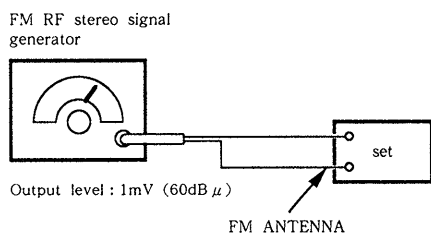

Procedure :

1. Tune the set to 98MHz.
2. Adjust T21 for 0V reading on the VOM.

**Note :** FM tuning level adjustment should be made after FM discriminator alignment.

### • FM Tuning Level Adjustment

Setting :

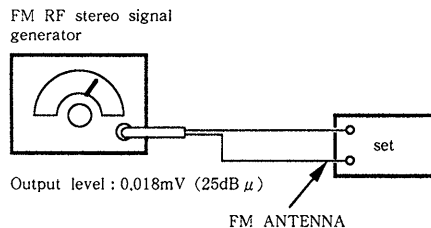

Procedure :

1. Tune the set to 98MHz.
2. Adjust RV24 so that the TUNED LED goes on.

### • FM Stereo Separation Adjustment

Setting :

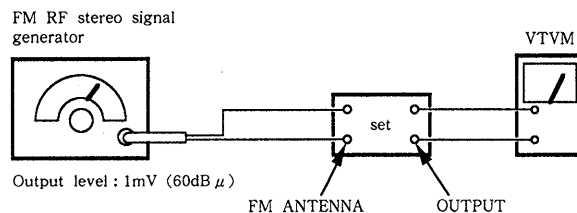

Procedure :

Tune the set to 98MHz

FM stereo Signal generator Output channel	VTVM connection	VTVM reading (dB)
L-CH	L-CH	Ⓐ
R-CH	L-CH	Ⓑ Adjust RV21 for minimum reading.
R-CH	R-CH	Ⓒ
L-CH	R-CH	Ⓓ Adjust RV21 for minimum reading.

L-CH Stereo separation : Ⓐ - Ⓑ

R-CH Stereo separation : Ⓒ - Ⓓ

The separations of both channels should be equal.

**AM SECTION**

**• AM Tuning Level Adjustment**

**Setting :**

BAND selector : LW

**Procedure :**

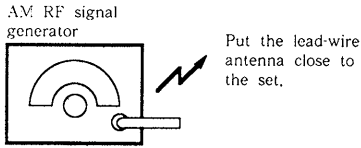

Carrier frequency : 216kHz

30% amplitude modulation by 400Hz signal  
Output level : 68dB  $\mu$

1. Tune the set to 216kHz
2. Adjust the RV22 so that the TUNED LED goes on.

**Parts Arrangement Diagram for Adjustments**

- tuner board -

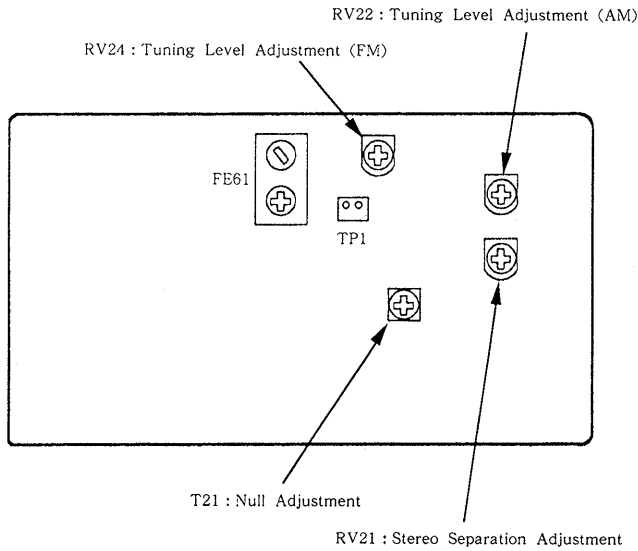

**Note on Ceramic Filter (CF1, 2) Replacement.**

This set employs three ceramic filters (CF1, 2) which should have the same color marking to identify their center frequency. Therefore FM IF offset adjustment by D708, D709 mounted is necessary to match the center frequency of the ceramic filters used with FM intermediate frequency.

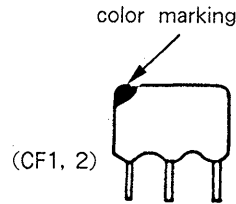

○ : Mounted  
× : not Mounted

Ceramic filter		Mount		FM intermediate frequency (MHz)
Color mark	Center frequency (MHz)	*A D708	*B D709	
White	10,750	×	○	10,750
Red	10,700	○	○	10,700
Black	10,650	○	×	10,650

FM intermediate frequency is determined by the three types as shown above. Ceramic filters of same center frequency, i. e., of same color coding should be used for CF1 and CF2. When replacing the ceramic filters, perform the FM Discriminator Adjustment.

**[Note on Inserting the Cord to the Connector on Tuner Board]**

- Insert the cord to the connector fitting Pin ① of the cord in accordance with the white mark on the board at the connector as shown in the figure.

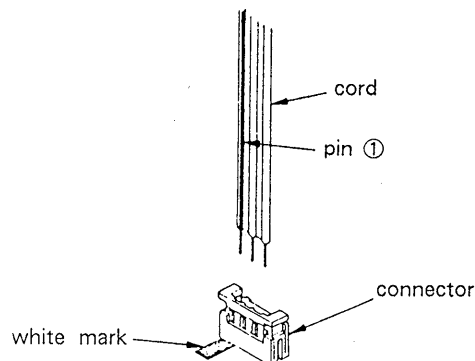

# SECTION 3 DIAGRAMS

## 3-1. SEMICONDUCTOR LEAD LAYOUTS

**LA5667**

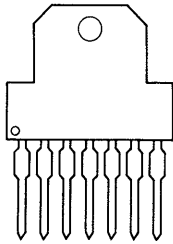

**2SK246-GR3**

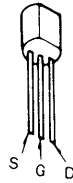

**2SA1175-HFE  
2SC2785-HFE**

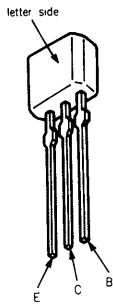

**1N4148M  
10E2N**

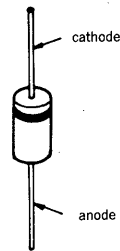

**2SB1116A-L**

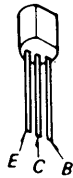

**HZS30-2L  
UZP-5.6B**

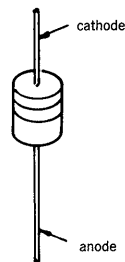

**2SC2603-EF  
2SC2669-OY  
2SC3113-AB  
DTA114ES  
DTC114ES  
DTC124ES**

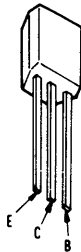

3-2. PRINTED WIRING BOARDS

● Semiconductor Location

Ref. No.	Location	Ref. No.	Location
D21	D-7	Q1	C-4
D22	D-8	Q2	C-4
D23	D-8	Q21	C-7
D24	D-8	Q22	C-7
D61	D-4	Q23	C-5
D601	I-11	Q24	C-5
D602	H-12	Q26	E-7
D603	I-5	Q27	C-7
D604	I-12	Q28	D-7
D606	I-5	Q61	D-4
D608	I-5	Q62	D-4
D609	I-7	Q63	D-4
D612	I-4	Q64	D-4
D613	I-4	Q65	D-5
D614	J-5	Q66	D-4
D615	I-4	Q81	B-5
D616	H-7	Q82	C-5
D617	H-7	Q83	B-3
D618	H-7	Q84	B-2
D619	I-5	Q85	B-2
D620	I-5	Q86	B-2
D621	I-5	Q601	I-6
D622	I-7	Q701	D-15
D701	E-15	Q801	B-14
D801	C-13	Q802	B-13
D802	B-13	Q803	A-12
D803	A-13		
D804	A-10		
D805	A-10		
D806	A-11		
D807	B-11		
IC21	D-6		
IC81	B-3		
IC601	I-8		
IC602	I-6		
IC801	C-15		

Note:  
 ● — : parts extracted from the component side.  
 ○ — : parts mounted on the conductor side.

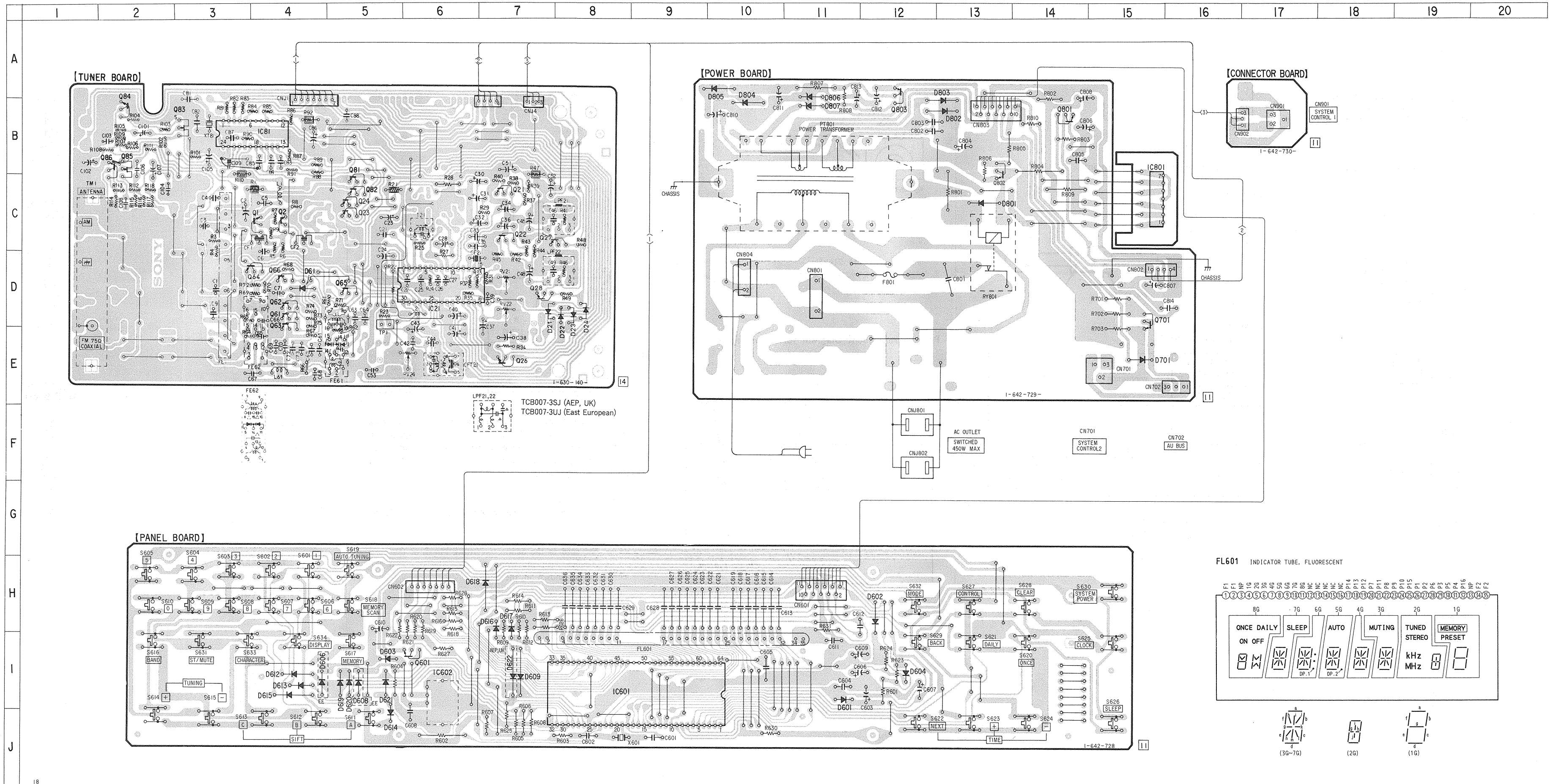

18

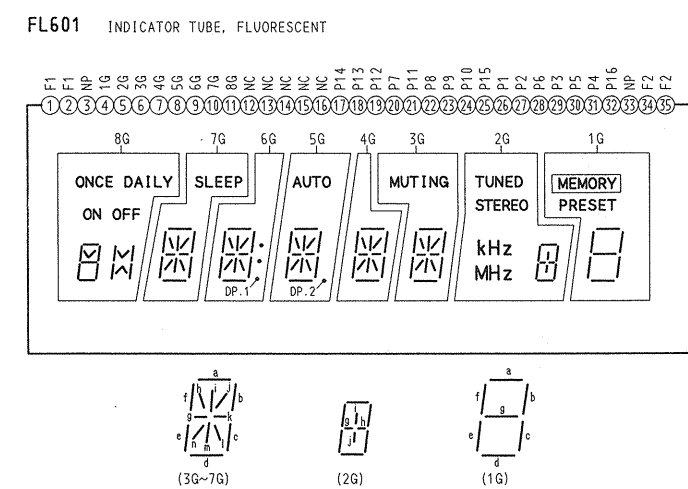

3-3. SCHEMATIC DIAGRAMS

- Note:**
- All capacitors are in  $\mu\text{F}$  unless otherwise noted.  $\text{pF}$ :  $\mu\text{F}$  50WV or less are not indicated except for electrolytics and tantalums.
  - All resistors are in  $\Omega$  and  $\frac{1}{4}\text{W}$  or less unless otherwise specified.
  - $\Delta$ : internal component.
  - $\square$ : nonflammable resistor.
- Note:** The components identified by mark  $\Delta$  or dotted line with mark  $\Delta$  are critical for safety. Replace only with part number specified.
- $\square$ : B+ Line
  - $\square$ : B- Line
  - $\square$ : adjustment for repair.
  - no mark: FM < > : LW
  - ( ): MW
  - Volts are taken with a VOM (Input impedance 10M $\Omega$ ).
  - Voltage variations may be noted due to normal production tolerances.
  - Signal path.
  - $\rightarrow$ : FM

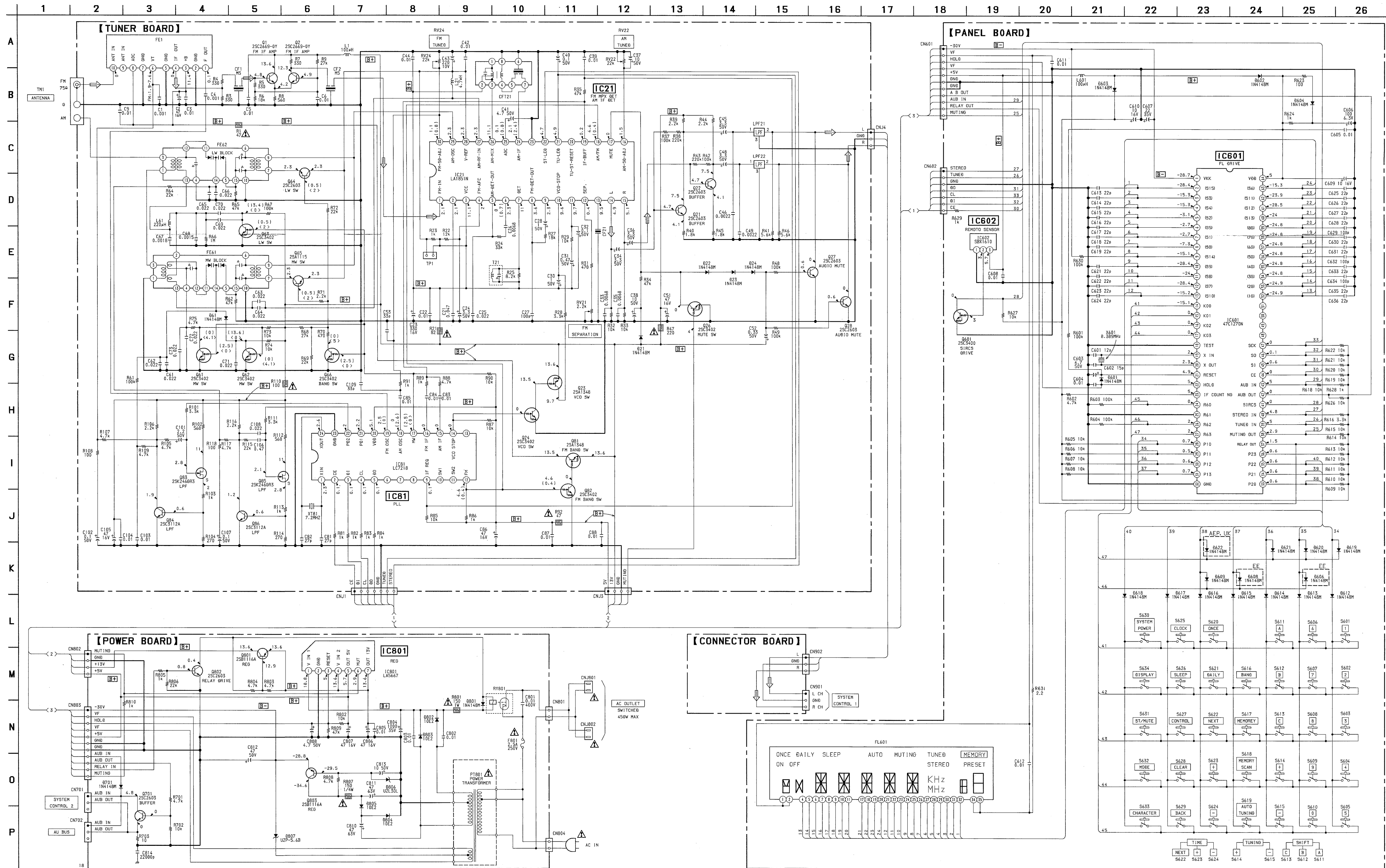

IC Block Diagrams

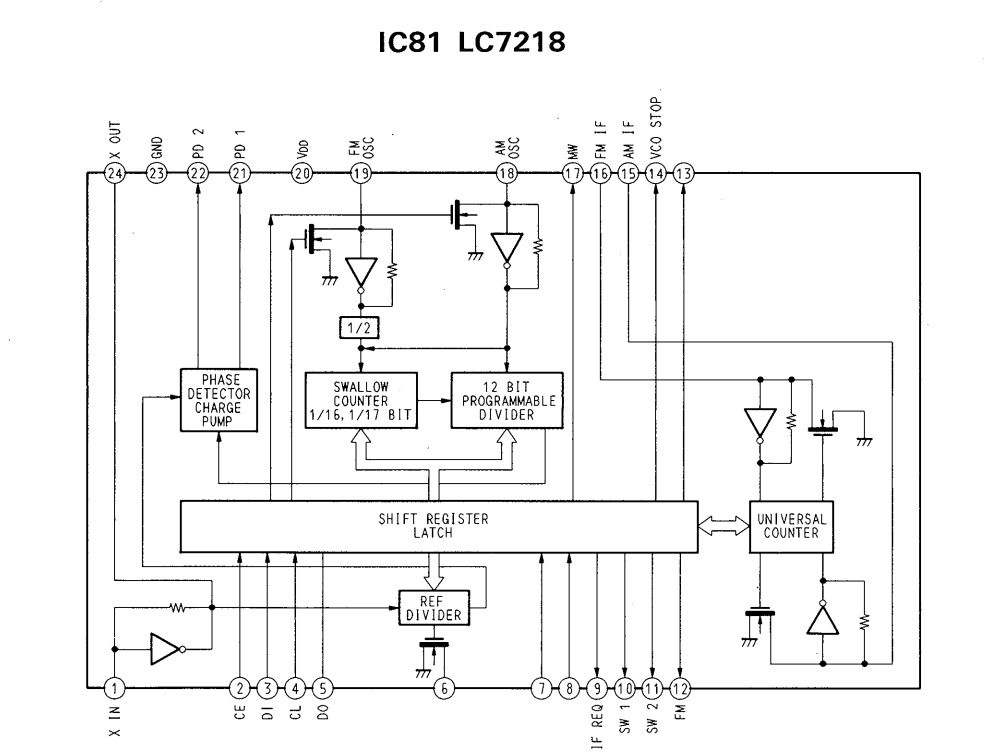
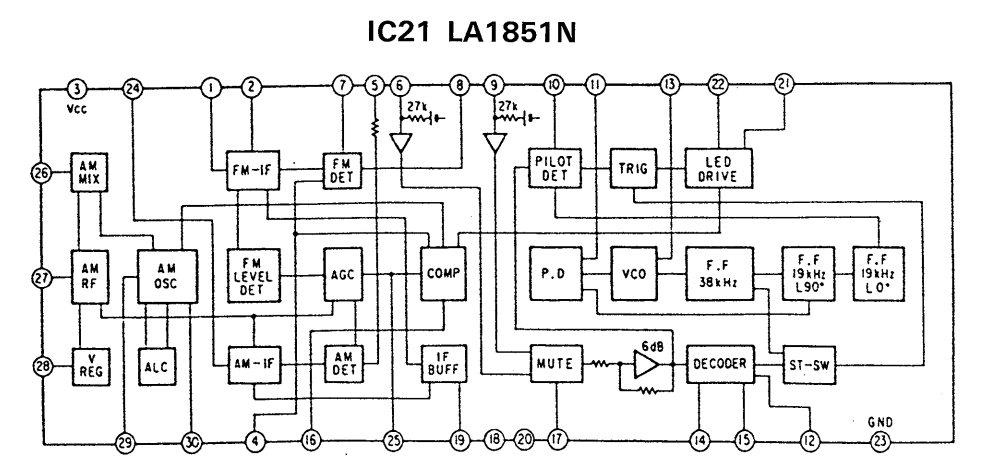
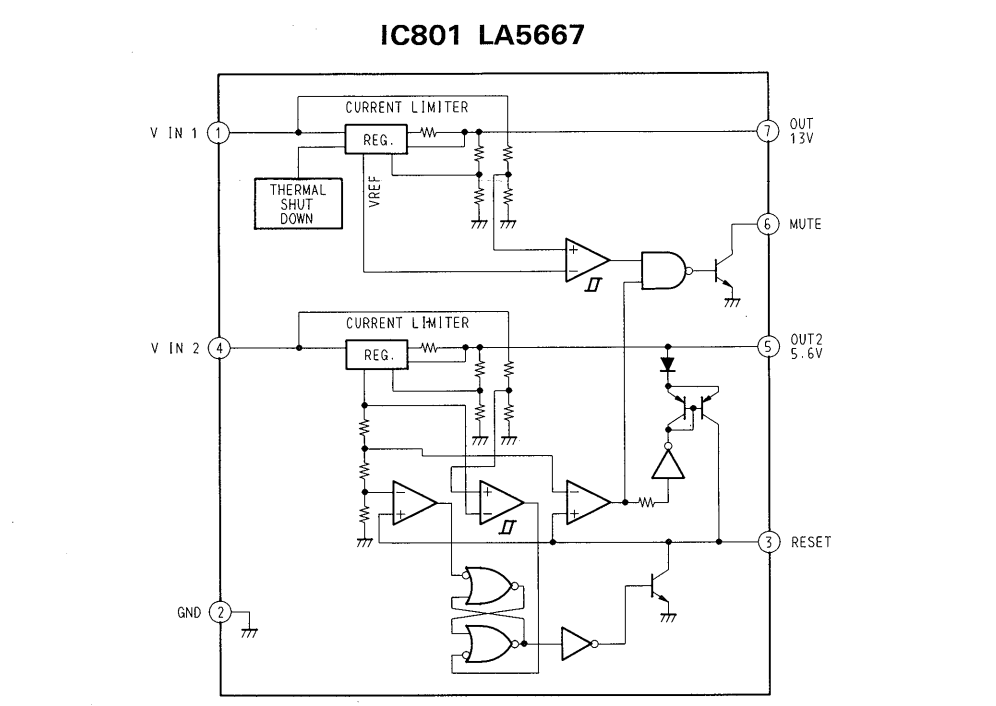



# SECTION 4 EXPLODED VIEWS

**NOTE:**

- -XX, -X mean standardized parts, so they may have some differences from the original one.

- Color Indication of Appearance Parts

Example:

KNOB, BALANCE(WHITE)...(RED)



- Items marked " \* " are not stocked since they are seldom required for routine service. Some delay should be anticipated when ordering these items.
- The mechanical parts with no reference number in the exploded views are not supplied.
- hardware (#mark) list is given in the last of this parts list.

The components identified by mark or dotted line with mark are critical for safety. Replace only with part number specified.

EE : East European Model

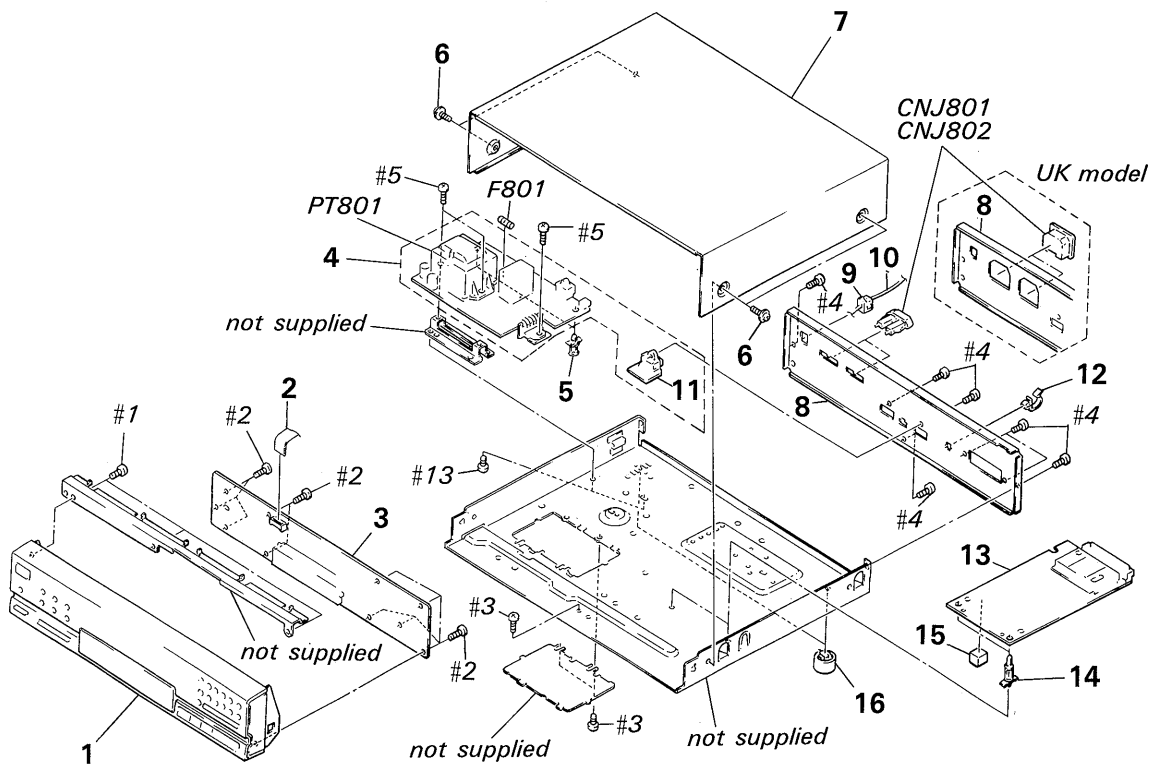

Ref. No.	Part No.	Description	Remark	Ref. No.	Part No.	Description	Remark
1	X-4942-442-1	PANEL ASSY (507), FRONT (FOR LBT-D507;AEP, UK, EE)			1-575-651-11	CORD, POWER (AEP, EE)	
1	X-4942-445-1	PANEL ASSY (607), FRONT (FOR LBT-D607;AEP, UK)			1-575-652-11	CORD, POWER (UK)	
2	1-575-666-11	WIRE, FLAT TYPE (11 CORE)		*	11	1-642-730-11	CONNECTOR BOARD
* 3	A-4347-291-A	PANEL BOARD, COMPLETE (AEP)		*	12	4-949-235-01	HOOK
* 3	A-4347-292-A	PANEL BOARD, COMPLETE (UK)		*	13	A-4347-288-A	TUNER BOARD, COMPLETE (AEP, UK)
* 3	A-4347-294-A	PANEL BOARD, COMPLETE (EE)		*	13	A-4347-290-A	TUNER BOARD, COMPLETE (EE)
* 4	A-4347-277-A	POWER BOARD, COMPLETE (AEP, EE)		*	14	4-924-098-31	HOLDER, PC BOARD
* 4	A-4347-278-A	POWER BOARD, COMPLETE (UK)			15	9-911-849-XX	CUSHION
* 5	3-349-025-31	HOLDER, PC BOARD			16	4-931-169-01	FOOT
6	3-363-099-01	SCREW (CASE +3X8 TP2)			F801	1-532-286-00	FUSE, TIME-LAG
* 7	4-939-802-31	CASE			PT801	1-449-979-11	TRANSFORMER, POWER
* 8	4-950-668-11	PANEL, BACK (AEP, EE)			CNJ801	1-526-794-11	OUTLET, AC (AEP, EE)
* 8	4-950-668-21	PANEL, BACK (UK)			CNJ802	1-526-794-11	OUTLET, AC (AEP, EE)
* 9	3-703-244-00	BUSHING (2104), CORD			CNJ801	1-526-751-00	OUTLET, AC (UK)
					CNJ802	1-526-751-00	OUTLET, AC (UK)



# SECTION 5 ELECTRICAL PARTS LIST

**PANEL**

**POWER**

**CONNECTOR**

**NOTE:**

- Due to standardization, replacements in the parts list may be different from the parts specified in the diagrams or the components used on the set.
- -XX, -X mean standardized parts, so they may have some differences from the original one.
- RESISTORS  
All resistors are in ohms  
METAL: Metal-film resistor  
METAL OXIDE: Metal Oxide-film resistor  
F: nonflammable

- Items marked " \* " are not stocked since they are seldom required for routine service. Some delay should be anticipated when ordering these items.
- SEMICONDUCTORS  
In each case, u:  $\mu$ , for example:  
uA...:  $\mu$ A..., uPA...:  $\mu$ PA...,  
uPB...:  $\mu$ PB..., uPC...:  $\mu$ PC...,  
uPD...:  $\mu$ PD...
- CAPACITORS  
uF:  $\mu$ F
- COILS  
uH:  $\mu$ H

When indication parts by reference number, please include the board name.

The components identified by mark  $\Delta$  or dotted line with mark  $\Delta$  are critical for safety. Replace only with part number specified.

Ref. No.	Part No.	Description	Remark	Ref. No.	Part No.	Description	Remark
*	A-4347-294-A	PANEL BOARD, COMPLETE (EE)		C621	1-162-207-31	CERAMIC 22PF 5%	50V
*	A-4347-292-A	PANEL BOARD, COMPLETE (UK)		C622	1-162-207-31	CERAMIC 22PF 5%	50V
*	A-4347-291-A	PANEL BOARD, COMPLETE (AEP)		C623	1-162-207-31	CERAMIC 22PF 5%	50V
		*****		C624	1-162-207-31	CERAMIC 22PF 5%	50V
*	A-4347-278-A	POWER BOARD, COMPLETE (UK)		C625	1-162-207-31	CERAMIC 22PF 5%	50V
*	A-4347-277-A	POWER BOARD, COMPLETE (AEP, EE)		C626	1-162-207-31	CERAMIC 22PF 5%	50V
		*****					
		CONNECTOR BOARD		C627	1-162-207-31	CERAMIC 22PF 5%	50V
		*****		C628	1-162-207-31	CERAMIC 22PF 5%	50V
*	4-921-941-01	CUSHION (FL)		C629	1-162-282-31	CERAMIC 100PF 10%	50V
*	4-923-103-01	HOLDER, FL TUBE		C630	1-162-207-31	CERAMIC 22PF 5%	50V
		< CAPACITOR >		C631	1-162-207-31	CERAMIC 22PF 5%	50V
C601	1-162-201-31	CERAMIC	12PF 5% 50V	C632	1-162-282-31	CERAMIC 100PF 10%	50V
C602	1-162-203-31	CERAMIC	15PF 5% 50V	C633	1-162-207-31	CERAMIC 22PF 5%	50V
C603	1-126-163-11	ELECT	4.7uF 20% 50V	C634	1-162-282-31	CERAMIC 100PF 10%	50V
C604	1-164-096-11	CERAMIC	0.01uF 50V	C635	1-162-207-31	CERAMIC 22PF 5%	50V
C605	1-161-379-00	CERAMIC	0.01uF 20% 25V	C636	1-162-207-31	CERAMIC 22PF 5%	50V
C606	1-126-177-11	ELECT	100uF 20% 10V	C801	1-161-744-00	CERAMIC 0.01uF	400V
C607	1-124-916-11	ELECT	22uF 20% 63V	C802	1-101-004-00	CERAMIC 0.01uF	50V
C608	1-164-096-11	CERAMIC	0.01uF 50V	C803	1-101-004-00	CERAMIC 0.01uF	50V
C609	1-126-157-11	ELECT	10uF 20% 16V	C804	1-126-105-11	ELECT 1000uF 20%	35V
C610	1-126-157-11	ELECT	10uF 20% 16V	C805	1-164-096-11	CERAMIC 0.01uF	50V
C611	1-164-096-11	CERAMIC	0.01uF 50V	C806	1-126-022-11	ELECT 47uF 20%	16V
C612	1-164-096-11	CERAMIC	0.01uF 50V	C807	1-126-022-11	ELECT 47uF 20%	16V
C613	1-162-207-31	CERAMIC	22PF 5% 50V	C808	1-126-163-11	ELECT 4.7uF 20%	50V
C614	1-162-207-31	CERAMIC	22PF 5% 50V	C810	1-124-918-11	ELECT 47uF 20%	63V
C615	1-162-207-31	CERAMIC	22PF 5% 50V	C811	1-124-918-11	ELECT 47uF 20%	63V
C616	1-162-207-31	CERAMIC	22PF 5% 50V	C812	1-124-910-11	ELECT 47uF 20%	50V
C617	1-162-207-31	CERAMIC	22PF 5% 50V	C813	1-126-059-11	ELECT 10uF 20%	50V
C618	1-162-207-31	CERAMIC	22PF 5% 50V	C814	1-162-596-11	CERAMIC 0.022uF	50V
C619	1-162-207-31	CERAMIC	22PF 5% 50V			< CONNECTOR >	
				* CN601	1-568-854-11	SOCKET, CONNECTOR 11P	
				* CN602	1-568-273-11	SOCKET, CONNECTOR 7P	

# PANEL

# POWER

# CONNECTOR

Ref. No.	Part No.	Description	Remark
* CN702	1-565-561-11	PIN, CONNECTOR 3P	
CN801	1-535-139-00	BASE POST 22MM (10MM PITCH) 2P	
* CN802	1-568-308-11	SOCKET, CONNECTOR 4P	
* CN803	1-568-830-11	SOCKET, CONNECTOR 11P	
* CN804	1-564-321-00	PIN, CONNECTOR 2P	
* CN901	1-569-625-41	SOCKET, CONNECTOR 3P	
CN902	1-568-269-11	SOCKET, CONNECTOR 3P	

### < DIODE >

D601	8-719-987-63	DIODE	1N4148M
D602	8-719-987-63	DIODE	1N4148M
D603	8-719-987-63	DIODE	1N4148M
D604	8-719-987-63	DIODE	1N4148M
D606	8-719-987-63	DIODE	1N4148M (EE)
D608	8-719-987-63	DIODE	1N4148M (EE)
D609	8-719-987-63	DIODE	1N4148M
D612	8-719-987-63	DIODE	1N4148M
D613	8-719-987-63	DIODE	1N4148M
D614	8-719-987-63	DIODE	1N4148M
D615	8-719-987-63	DIODE	1N4148M
D616	8-719-987-63	DIODE	1N4148M
D617	8-719-987-63	DIODE	1N4148M
D618	8-719-987-63	DIODE	1N4148M
D619	8-719-987-63	DIODE	1N4148M
D620	8-719-987-63	DIODE	1N4148M
D621	8-719-987-63	DIODE	1N4148M
D622	8-719-987-63	DIODE	1N4148M (AEP, UK)
D701	8-719-987-63	DIODE	1N4148M
D801	8-719-987-63	DIODE	1N4148M
D802	8-719-200-77	DIODE	10E2N
D803	8-719-200-77	DIODE	10E2N
D804	8-719-200-77	DIODE	10E2N
D805	8-719-200-77	DIODE	10E2N
D806	8-719-934-22	DIODE	HZS30-2L
D807	8-719-014-66	DIODE	UZP-5.6B

### < FUSE >



 F801 1-532-286-00 FUSE, TIME-LAG (2.5A/250V)

### < FUSE HOLDER >

\* FH801 1-533-213-31 HOLDER, FUSE  
 \* FH802 1-533-213-31 HOLDER, FUSE

### < FLUORESCENT INDICATOR >

FL601 1-519-728-11 INDICATOR TUBE, FLUORESCENT

The components identified by mark  or dotted line with mark  are critical for safety. Replace only with part number specified.

Ref. No.	Part No.	Description	Remark
		< IC >	
IC601	8-759-053-98	IC TMP47C1270AN-H204	
IC602	8-741-100-48	IC SBX1610-59	
IC801	8-759-820-09	IC LA5667	

### < TRANSFORMER >

PT801 1-449-979-11 TRANSFORMER, POWER

### < TRANSISTOR >

Q601	8-729-900-36	TRANSISTOR	DTC124ES
Q701	8-729-620-05	TRANSISTOR	2SC2603-EF
Q801	8-729-140-04	TRANSISTOR	2SB1116A-L
Q802	8-729-620-05	TRANSISTOR	2SC2603-EF
Q803	8-729-140-04	TRANSISTOR	2SB1116A-L

### < RESISTOR >

R601	1-249-441-11	CARBON	100K	5%	1/4W
R602	1-249-429-11	CARBON	10K	5%	1/4W
R603	1-249-441-11	CARBON	100K	5%	1/4W
R604	1-249-441-11	CARBON	100K	5%	1/4W
R605	1-249-429-11	CARBON	10K	5%	1/4W
R606	1-249-429-11	CARBON	10K	5%	1/4W
R607	1-249-429-11	CARBON	10K	5%	1/4W
R608	1-249-429-11	CARBON	10K	5%	1/4W
R609	1-249-429-11	CARBON	10K	5%	1/4W
R610	1-249-429-11	CARBON	10K	5%	1/4W
R611	1-249-429-11	CARBON	10K	5%	1/4W
R612	1-249-429-11	CARBON	10K	5%	1/4W
R613	1-249-425-11	CARBON	4.7K	5%	1/4W
R614	1-249-429-11	CARBON	10K	5%	1/4W
R615	1-249-429-11	CARBON	10K	5%	1/4W
R616	1-249-423-11	CARBON	3.3K	5%	1/4W
R618	1-249-417-11	CARBON	1K	5%	1/4W
R619	1-249-429-11	CARBON	10K	5%	1/4W
R620	1-249-429-11	CARBON	10K	5%	1/4W
R621	1-249-429-11	CARBON	10K	5%	1/4W
R622	1-249-429-11	CARBON	10K	5%	1/4W
R623	1-249-405-11	CARBON	100	5%	1/4W
R624	1-249-417-11	CARBON	1K	5%	1/4W
R625	1-249-441-11	CARBON	100K	5%	1/4W
R626	1-249-429-11	CARBON	10K	5%	1/4W
R627	1-249-429-11	CARBON	10K	5%	1/4W
R628	1-249-417-11	CARBON	1K	5%	1/4W
R629	1-249-417-11	CARBON	1K	5%	1/4W
R630	1-249-441-11	CARBON	100K	5%	1/4W
R631	1-249-421-11	CARBON	2.2	5%	1/4W
R701	1-249-425-11	CARBON	4.7K	5%	1/4W
R702	1-249-429-11	CARBON	10K	5%	1/4W
R703	1-249-393-11	CARBON	10	5%	1/4W

# PANEL POWER CONNECTOR

Ref. No.	Part No.	Description	Remark
△ R801	1-215-864-00	METAL OXIDE	150 5% 1W F
R802	1-249-429-11	CARBON	10K 5% 1/4W
R803	1-249-425-11	CARBON	4.7K 5% 1/4W
R804	1-249-425-11	CARBON	4.7K 5% 1/4W
R805	1-249-417-11	CARBON	1K 5% 1/4W
R806	1-249-433-11	CARBON	22K 5% 1/4W
△ R807	1-247-702-11	CARBON	150 5% 1/4W F
R808	1-249-425-11	CARBON	4.7K 5% 1/4W
R809	1-249-437-11	CARBON	47K 5% 1/4W
R810	1-249-417-11	CARBON	1K 5% 1/4W
< RELAY >			
RY801	1-515-617-11	RELAY	
< SWITCH >			
S601	1-554-303-21	SWITCH, TACTILE (1)	
S602	1-554-303-21	SWITCH, TACTILE (2)	
S603	1-554-303-21	SWITCH, TACTILE (3)	
S604	1-554-303-21	SWITCH, TACTILE (4)	
S605	1-554-303-21	SWITCH, TACTILE (5)	
S606	1-554-303-21	SWITCH, TACTILE (6)	
S607	1-554-303-21	SWITCH, TACTILE (7)	
S608	1-554-303-21	SWITCH, TACTILE (8)	
S609	1-554-303-21	SWITCH, TACTILE (9)	
S610	1-554-303-21	SWITCH, TACTILE (0)	
S611	1-554-303-21	SWITCH, TACTILE (SHIFT A)	
S612	1-554-303-21	SWITCH, TACTILE (SHIFT B)	
S613	1-554-303-21	SWITCH, TACTILE (SHIFT C)	
S614	1-554-303-21	SWITCH, TACTILE (TUNING +)	
S615	1-554-303-21	SWITCH, TACTILE (TUNING -)	
S616	1-554-303-21	SWITCH, TACTILE (BAND)	
S617	1-554-303-21	SWITCH, TACTILE (MEMORY)	
S618	1-554-303-21	SWITCH, TACTILE (MEMORY SCAN)	
S619	1-554-303-21	SWITCH, TACTILE (AUTO TUNING)	
S620	1-554-303-21	SWITCH, TACTILE (ONCE)	
S621	1-554-303-21	SWITCH, TACTILE (DAILY)	
S622	1-554-303-21	SWITCH, TACTILE (TIME NEXT)	
S623	1-554-303-21	SWITCH, TACTILE (TIME +)	
S624	1-554-303-21	SWITCH, TACTILE (TIME -)	
S625	1-554-303-21	SWITCH, TACTILE (CLOCK)	
S626	1-554-303-21	SWITCH, TACTILE (SLEEP)	
S627	1-554-303-21	SWITCH, TACTILE (CONTROL)	
S628	1-554-303-21	SWITCH, TACTILE (CLEAR)	
S629	1-554-303-21	SWITCH, TACTILE (BACK)	
S630	1-554-303-21	SWITCH, TACTILE (SYSTEM POWER)	
S631	1-554-303-21	SWITCH, TACTILE (ST/MUTE)	
S632	1-554-303-21	SWITCH, TACTILE (MODE)	
S633	1-554-303-21	SWITCH, TACTILE (CHARACTER)	

Ref. No.	Part No.	Description	Remark
S634	1-554-303-21	SWITCH, TACTILE (DISPLAY)	
< CRYSTAL >			
X601	1-579-564-11	VIBRATOR, CRYSTAL (8.389MHZ)	
*****			
*	A-4347-290-A	TUNER BOARD, COMPLETE (EE)	
*	A-4347-288-A	TUNER BOARD, COMPLETE (AEP, UK)	
*****			
	1-589-204-11	TUNER BOARD (AEP, EE, UK)	
*	4-924-988-11	PLATE (ST), GROUND	
< CAPACITOR >			
C1	1-162-294-31	CERAMIC	1000PF 20% 25V
C2	1-124-477-11	ELECT	47uF 20% 25V
C3	1-163-059-00	CERAMIC CHIP	0.01uF 20% 16V
C4	1-162-294-31	CERAMIC	1000PF 20% 25V
C5	1-163-059-00	CERAMIC CHIP	0.01uF 20% 16V
C6	1-163-059-00	CERAMIC CHIP	0.01uF 20% 16V
C9	1-163-059-00	CERAMIC CHIP	0.01uF 20% 16V
C21	1-101-006-00	CERAMIC	0.047uF 50V
C22	1-163-059-00	CERAMIC CHIP	0.01uF 20% 16V
C23	1-124-119-00	ELECT	330uF 20% 16V
C24	1-123-382-00	ELECT	3.3uF 20% 100V
C25	1-163-063-00	CERAMIC CHIP	22000PF 25V
C26	1-163-019-00	CERAMIC CHIP	6800PF 20% 12V
C27	1-162-516-11	CERAMIC CHIP	100PF 10% 50V
C28	1-124-903-11	ELECT	1uF 20% 50V
C30	1-124-903-11	ELECT	1uF 20% 50V
C31	1-124-902-00	ELECT	0.47uF 20% 50V
C32	1-124-463-00	ELECT	0.1uF 20% 50V
C33	1-130-481-00	MYLAR	0.0068uF 5% 50V
C34	1-123-382-00	ELECT	3.3uF 20% 100V
C35	1-130-481-00	MYLAR	0.0068uF 5% 50V
C36	1-123-382-00	ELECT	3.3uF 20% 100V
C37	1-124-907-11	ELECT	10uF 20% 50V
C38	1-124-907-11	ELECT	10uF 20% 50V
C39	1-163-059-00	CERAMIC CHIP	0.01uF 20% 16V
C40	1-124-463-00	ELECT	0.1uF 20% 50V
C41	1-124-927-11	ELECT	4.7uF 20% 100V
C42	1-163-059-00	CERAMIC CHIP	0.01uF 20% 16V
C43	1-126-176-11	ELECT	220uF 20% 10V
C44	1-163-059-00	CERAMIC CHIP	0.01uF 20% 16V
C45	1-123-382-00	ELECT	3.3uF 20% 100V
C46	1-161-375-00	CERAMIC	2200PF 20% 25V
C48	1-123-382-00	ELECT	3.3uF 20% 100V
C49	1-161-375-00	CERAMIC	2200PF 20% 25V

The components identified by mark **△** or dotted line with mark **△** are critical for safety. Replace only with part number specified.

## TUNER

Ref. No.	Part No.	Description	Remark
C51	1-124-477-11	ELECT	47uF 20% 25V
C52	1-124-252-00	ELECT	0.33uF 20% 50V
C53	1-163-105-00	CERAMIC CHIP	33PF 5% 50V
C61	1-163-063-00	CERAMIC CHIP	22000PF 25V
C62	1-163-063-00	CERAMIC CHIP	22000PF 25V
C63	1-163-063-00	CERAMIC CHIP	22000PF 25V
C64	1-163-063-00	CERAMIC CHIP	22000PF 25V
C65	1-163-063-00	CERAMIC CHIP	22000PF 25V
C66	1-163-063-00	CERAMIC CHIP	22000PF 25V
C67	1-102-120-00	CERAMIC	0.0018uF 10% 50V
C68	1-163-011-11	CERAMIC CHIP	1500PF 20% 25V
C69	1-163-063-00	CERAMIC CHIP	22000PF 25V
C70	1-163-063-00	CERAMIC CHIP	22000PF 25V
C71	1-163-063-00	CERAMIC CHIP	22000PF 25V
C72	1-163-063-00	CERAMIC CHIP	22000PF 25V
C73	1-163-063-00	CERAMIC CHIP	22000PF 25V
C81	1-102-961-00	CERAMIC	27PF 5% 50V
C82	1-102-961-00	CERAMIC	27PF 5% 50V
C83	1-163-059-00	CERAMIC CHIP	0.01uF 20% 16V
C84	1-163-059-00	CERAMIC CHIP	0.01uF 20% 16V
C85	1-163-059-00	CERAMIC CHIP	0.01uF 20% 16V
C86	1-124-477-11	ELECT	47uF 20% 25V
C87	1-163-059-00	CERAMIC CHIP	0.01uF 20% 16V
C88	1-163-059-00	CERAMIC CHIP	0.01uF 20% 16V
C101	1-124-925-11	ELECT	2.2uF 20% 100V
C102	1-124-463-00	ELECT	0.1uF 20% 50V
C103	1-163-059-00	CERAMIC CHIP	0.01uF 20% 16V
C104	1-163-059-00	CERAMIC CHIP	0.01uF 20% 16V
C105	1-124-477-11	ELECT	47uF 20% 25V
C106	1-136-173-00	FILM	0.47uF 5% 50V
C107	1-124-463-00	ELECT	0.1uF 20% 50V
C108	1-163-063-00	CERAMIC CHIP	22000PF 25V
C109	1-102-963-00	CERAMIC	33PF 5% 50V
< CERAMIC FILTER >			
CF1	1-567-389-11	FILTER, CERAMIC	
CF2	1-567-389-11	FILTER, CERAMIC	
CF21	1-577-075-11	OSCILLATOR, CERAMIC	
CFT21	1-404-853-11	TRANSFORMER, IF (CERAMIC FILTER)	
< CONNECTOR >			
* CNJ1	1-568-273-11	SOCKET, CONNECTOR 7P	
* CNJ3	1-568-308-11	SOCKET, CONNECTOR 4P	
CNJ4	1-568-269-11	SOCKET, CONNECTOR 3P	
< DIODE >			
D21	8-719-987-63	DIODE 1N4148M	
D22	8-719-987-63	DIODE 1N4148M	
D23	8-719-987-63	DIODE 1N4148M	

Ref. No.	Part No.	Description	Remark
D24	8-719-987-63	DIODE 1N4148M	
D61	8-719-987-63	DIODE 1N4148M	
< FRONT END >			
FE1	1-463-862-21	FRONT END, FM (AEP, UK)	
FE1	1-465-560-11	FRONT END (FM 3 GANG) (EE)	
FE61	1-236-462-11	ENCAPSULATED COMPONENT	
FE62	1-236-463-11	ENCAPSULATED COMPONENT	
< IC >			
IC21	8-759-821-45	IC LA1851N	
IC81	8-759-820-91	IC LC7218	
< COIL >			
L1	1-410-645-31	INDUCTOR 100uH	
L21	1-407-500-00	INDUCTOR 4.7mH	
L61	1-410-525-11	INDUCTOR 220uH	
< LOW PASS FILTER >			
LPF21	1-235-164-00	FILTER, LOW PASS	
LPF22	1-235-164-00	FILTER, LOW PASS	
< TRANSISTOR >			
Q1	8-729-230-XX	TRANSISTOR 2SC2669-0Y	
Q2	8-729-230-XX	TRANSISTOR 2SC2669-0Y	
Q21	8-729-119-78	TRANSISTOR 2SC2785-HFE	
Q22	8-729-119-78	TRANSISTOR 2SC2785-HFE	
Q23	8-729-900-61	TRANSISTOR DTA114ES	
Q24	8-729-900-80	TRANSISTOR DTC114ES	
Q26	8-729-900-80	TRANSISTOR DTC114ES	
Q27	8-729-620-05	TRANSISTOR 2SC2603-EF	
Q28	8-729-620-05	TRANSISTOR 2SC2603-EF	
Q61	8-729-900-80	TRANSISTOR DTC114ES	
Q62	8-729-900-80	TRANSISTOR DTC114ES	
Q63	8-729-900-80	TRANSISTOR DTC114ES	
Q64	8-729-620-05	TRANSISTOR 2SC2603-EF	
Q65	8-729-119-76	TRANSISTOR 2SA1175-HFE	
Q66	8-729-900-80	TRANSISTOR DTC114ES	
Q81	8-729-900-61	TRANSISTOR DTA114ES	
Q82	8-729-900-80	TRANSISTOR DTC114ES	
Q83	8-729-202-67	TRANSISTOR 2SK246-GR3	
Q84	8-729-230-93	TRANSISTOR 2SC3113-AB	
Q85	8-729-202-67	TRANSISTOR 2SK246-GR3	
Q86	8-729-230-93	TRANSISTOR 2SC3113-AB	
< RESISTOR >			
△ R1	1-249-401-11	CARBON 47 5% 1/4W F	
R3	1-249-329-11	CARBON MELF 330 5% 1/8W	

The components identified by mark  $\Delta$  or dotted line with mark  $\Delta$  are critical for safety. Replace only with part number specified.

## TUNER

Ref. No.	Part No.	Description	Remark			Ref. No.	Part No.	Description	Remark		
R4	1-249-329-11	CARBON MELF	330	5%	1/8W	R83	1-249-335-11	CARBON MELF	1K	5%	1/8W
R5	1-249-329-11	CARBON MELF	330	5%	1/8W	R84	1-249-335-11	CARBON MELF	1K	5%	1/8W
R6	1-249-350-11	CARBON MELF	18K	5%	1/8W	R85	1-249-347-11	CARBON MELF	10K	5%	1/8W
R7	1-249-329-11	CARBON MELF	330	5%	1/8W	R86	1-249-335-11	CARBON MELF	1K	5%	1/8W
R8	1-249-332-11	CARBON MELF	560	5%	1/8W	R87	1-249-347-11	CARBON MELF	10K	5%	1/8W
R9	1-249-352-11	CARBON MELF	27K	5%	1/8W	R88	1-249-343-11	CARBON MELF	4.7K	5%	1/8W
△R21	1-249-404-00	CARBON	82	5%	1/4W F	R89	1-249-335-11	CARBON MELF	1K	5%	1/8W
R22	1-249-430-11	CARBON	12K	5%	1/4W	R90	1-249-343-11	CARBON MELF	4.7K	5%	1/8W
R23	1-249-335-11	CARBON MELF	1K	5%	1/8W	R91	1-249-335-11	CARBON MELF	1K	5%	1/8W
R24	1-249-353-11	CARBON MELF	33K	5%	1/8W	△R92	1-249-401-11	CARBON	47	5%	1/4W F
R25	1-249-346-11	CARBON MELF	8.2K	5%	1/8W	R101	1-249-341-11	CARBON MELF	3.3K	5%	1/8W
R27	1-249-432-11	CARBON	18K	5%	1/4W	R102	1-249-332-11	CARBON MELF	560	5%	1/8W
R28	1-249-423-11	CARBON	3.3K	5%	1/4W	R103	1-249-335-11	CARBON MELF	1K	5%	1/8W
R29	1-249-347-11	CARBON MELF	10K	5%	1/8W	R104	1-249-328-11	CARBON MELF	270	5%	1/8W
R31	1-249-331-11	CARBON MELF	470	5%	1/8W	R105	1-249-343-11	CARBON MELF	4.7K	5%	1/8W
R32	1-249-347-11	CARBON MELF	10K	5%	1/8W	R106	1-249-339-11	CARBON MELF	2.2K	5%	1/8W
R33	1-249-347-11	CARBON MELF	10K	5%	1/8W	R107	1-249-343-11	CARBON MELF	4.7K	5%	1/8W
R34	1-249-425-11	CARBON	4.7K	5%	1/4W	R108	1-249-323-11	CARBON MELF	100	5%	1/8W
R35	1-249-355-11	CARBON MELF	47K	5%	1/8W	R109	1-249-343-11	CARBON MELF	4.7K	5%	1/8W
R37	1-249-359-11	CARBON MELF	100K	5%	1/8W	△R110	1-249-405-11	CARBON	100	5%	1/4W F
R38	1-249-363-11	CARBON MELF	220K	5%	1/8W	R111	1-249-341-11	CARBON MELF	3.3K	5%	1/8W
R39	1-249-339-11	CARBON MELF	2.2K	5%	1/8W	R112	1-249-332-11	CARBON MELF	560	5%	1/8W
R40	1-249-338-11	CARBON MELF	1.8K	5%	1/8W	R113	1-249-335-11	CARBON MELF	1K	5%	1/8W
R41	1-249-344-11	CARBON MELF	5.6K	5%	1/8W	R114	1-249-328-11	CARBON MELF	270	5%	1/8W
R42	1-249-359-11	CARBON MELF	100K	5%	1/8W	R115	1-249-351-11	CARBON MELF	22K	5%	1/8W
R43	1-249-363-11	CARBON MELF	220K	5%	1/8W	R116	1-249-339-11	CARBON MELF	2.2K	5%	1/8W
R44	1-249-339-11	CARBON MELF	2.2K	5%	1/8W	R117	1-249-343-11	CARBON MELF	4.7K	5%	1/8W
R45	1-249-338-11	CARBON MELF	1.8K	5%	1/8W	R118	1-249-323-11	CARBON MELF	100	5%	1/8W
R46	1-249-344-11	CARBON MELF	5.6K	5%	1/8W			< VARIABLE RESISTOR >			
△R47	1-249-409-11	CARBON	220	5%	1/4W F	RV21	1-238-013-11	RES. ADJ. CARBON 2.2K			
R48	1-249-359-11	CARBON MELF	100K	5%	1/8W	RV22	1-238-017-11	RES. ADJ. CARBON 22K			
R49	1-249-359-11	CARBON MELF	100K	5%	1/8W	RV24	1-238-017-11	RES. ADJ. CARBON 22K			
R61	1-249-359-11	CARBON MELF	100K	5%	1/8W			< TRANSFORMER >			
R62	1-249-355-11	CARBON MELF	47K	5%	1/8W	T21	1-404-807-11	TRANSFORMER, DISCRIMINATOR			
R64	1-249-351-11	CARBON MELF	22K	5%	1/8W			< TERMINAL BOARD >			
R65	1-249-355-11	CARBON MELF	47K	5%	1/8W	* TM1	1-537-138-31	TERMINAL BOARD (ANT)			
R66	1-215-493-00	METAL	1M	5%	1/4W			< TEST POINT >			
R67	1-249-359-11	CARBON MELF	100K	5%	1/8W	* TP1	1-560-060-00	PIN, CONNECTOR 2P			
R68	1-249-352-11	CARBON MELF	27K	5%	1/8W			< CRYSTAL >			
R69	1-249-351-11	CARBON MELF	22K	5%	1/8W	XT81	1-577-126-11	VIBRATOR, CRYSTAL (7.2MHz)			
R70	1-249-331-11	CARBON MELF	470	5%	1/8W			*****			
R71	1-249-339-11	CARBON MELF	2.2K	5%	1/8W						
R72	1-249-351-11	CARBON MELF	22K	5%	1/8W						
R73	1-249-347-11	CARBON MELF	10K	5%	1/8W						
R74	1-249-347-11	CARBON MELF	10K	5%	1/8W						
R75	1-249-343-11	CARBON MELF	4.7K	5%	1/8W						
R81	1-249-335-11	CARBON MELF	1K	5%	1/8W						
R82	1-249-335-11	CARBON MELF	1K	5%	1/8W						

The components identified by mark △ or dotted line with mark △ are critical for safety. Replace only with part number specified.

Ref. No.	Part No.	Description	Remark
----------	----------	-------------	--------

MISCELLANEOUS  
\*\*\*\*\*

△10	1-575-651-11	CORD, POWER (AEP, EE)	
△10	1-575-652-11	CORD, POWER (UK)	
2	1-575-666-11	WIRE, FLAT TYPE (11 CORE)	
△CNJ801	1-526-751-00	OUTLET, AC (UK)	
△CNJ801	1-526-794-11	OUTLET, AC (AEP, EE)	
△CNJ802	1-526-751-00	OUTLET, AC (UK)	
△CNJ802	1-526-794-11	OUTLET, AC (AEP, EE)	

\*\*\*\*\*

ACCESSORIES & PACKING MATERIALS  
\*\*\*\*\*

	4-920-940-01	SHEET (A), PROTECTION	
*	4-929-563-01	CUSHION	
*	4-952-208-01	INDIVIDUAL CARTON (FOR LBT-D507;AEP)	
*	4-952-209-01	INDIVIDUAL CARTON (FOR LBT-D607;AEP)	

\*\*\*\*\*

### HARDWARE LIST

#1	7-685-134-19	SCREW +BTP 2.6X8 TYPE2 N-S
#2	7-621-773-93	SCREW (PANEL 2.6 TP2)
#3	7-685-646-79	SCREW +BVTP 3X8 TYPE2 N-S
#4	7-621-849-00	SCREW (BV/RING)
#5	7-685-647-79	SCREW +BVTP 3X10 TYPE2 N-S

The components identified by mark △ or dotted line with mark △ are critical for safety. Replace only with part number specified.





# ST-D707

## SONY<sup>®</sup> SERVICE MANUAL

*AEP Model*  
*UK Model*  
*East European Model*

### SUPPLEMENT-1

File this supplement with the service manual.

**Subject :** Addition to Germany and Italian models.

The model for Germany and Italian have been added to ST-D707.  
ST-D707 (Germany and Italian models) is almost same as the ST-D707 (AEP model) and only the difference from ST-D707 (AEP model) is described in this manual.  
Refer to the ST-D707 (AEP model) SERVICE MANUAL for the other information.

#### EXPLODED VIEWS

Page	No.	Part No.	Description
13	1	X-4942-442-1	PANEL ASSY (507), FRONT (FOR LBT-D507 ; G)
	1	X-4942-444-1	PANEL ASSY (507), FRONT (FOR LBT-D507 ; IT)
	1	X-4942-445-1	PANEL ASSY (607), FRONT (FOR LBT-D607 ; G)
	1	X-4942-447-1	PANEL ASSY (607), FRONT (FOR LBT-D607 ; IT)
	1	X-4942-731-1	PANEL ASSY (707), FRONT (FOR LBT-D707 ; G)
	1	X-4942-733-1	PANEL ASSY (707), FRONT (FOR LBT-D707 ; IT)
	3	*A-4347-295-A	PANEL BOARD, COMPLETE (IT)
	3	*A-4347-296-A	PANEL BOARD, COMPLETE (G)
	4	*A-4347-286-A	PANEL BOARD, COMPLETE (G, IT)
	7	*4-939-802-71	CASE (IT)
	8	*4-950-668-31	PANEL, BACK (G)
	8	*4-950-668-41	PANEL, BACK (IT)
	13	*A-4347-289-A	TUNER (3TJ) BOARD, COMPLETE

●Items marked "\*" are not stocked since they are seldom required for routine service. Some delay should be anticipated when ordering these items.

NOTE  
G : Germany  
IT : Italian

## SPECIFICATIONS

System	FM stereo FM/AM superheterodyne tuner
FM tuner section	
Tuning range	87.5 to 108 MHz
Antenna	75 ohms unbalanced
Intermediate frequency	10.7 MHz
AM tuner section	
Tuning range	MW : 522 to 1.611 kHz (Italian model) 531 to 1.602 kHz (Germany model) LW : 144 to 288 kHz (Italian model) 153 to 279 kHz (Germany model)
Antenna	AM loop antenna External antenna terminal
Intermediate frequency	450 kHz
Power requirements	220-230 V AC, 50/60 Hz
Power consumption	10 W
AC outlet	2 switched, total 450 W max.
Weight	Approx. 2.7 kg (6 lbs 5 oz)
Dimensions	Approx. 355 × 95 × 310 mm (14 × 3 <sup>3</sup> / <sub>4</sub> × 12 <sup>1</sup> / <sub>4</sub> inches) (w/h/d, including projections)

Design and specifications are subject to change without notice.

### NOTE

This appliance conforms with EEC Directive 87/308/EEC regarding interference suppression.



3-2. PRINTED WIRING BOARDS

● Semiconductor Location

Ref. No.	Location	Ref. No.	Location
D21	D-7	Q1	C-4
D22	D-8	Q2	C-4
D23	D-8	Q3	C-4
D24	D-8	Q4	C-5
D61	D-4	Q21	C-7
D601	I-11	Q22	C-7
D602	H-12	Q23	C-5
D603	I-5	Q24	C-5
D604	I-12	Q26	E-7
D605	I-5	Q27	C-7
D609	I-7	Q28	D-7
D612	I-4	Q61	D-4
D613	I-4	Q62	D-4
D614	J-5	Q63	D-4
D615	I-4	Q64	D-4
D616	H-7	Q65	D-5
D617	H-7	Q66	D-4
D618	H-7	Q81	B-5
D619	I-5	Q82	C-5
D620	I-5	Q83	B-3
D621	I-5	Q84	B-2
D622	I-7	Q85	B-2
D701	E-15	Q86	B-2
D801	C-13	Q601	I-6
D802	B-13	Q701	D-15
D803	A-13	Q801	B-14
D804	A-10	Q802	B-13
D805	A-10	Q803	A-12
D806	A-11		
D807	B-11		
IC301	D-6		
IC501	B-3		
IC601	I-8		
IC602	I-6		
IC100	C-15		

Note:  
 ● ○ : parts extracted from the component side.  
 ● ■ : parts mounted on the conductor side.

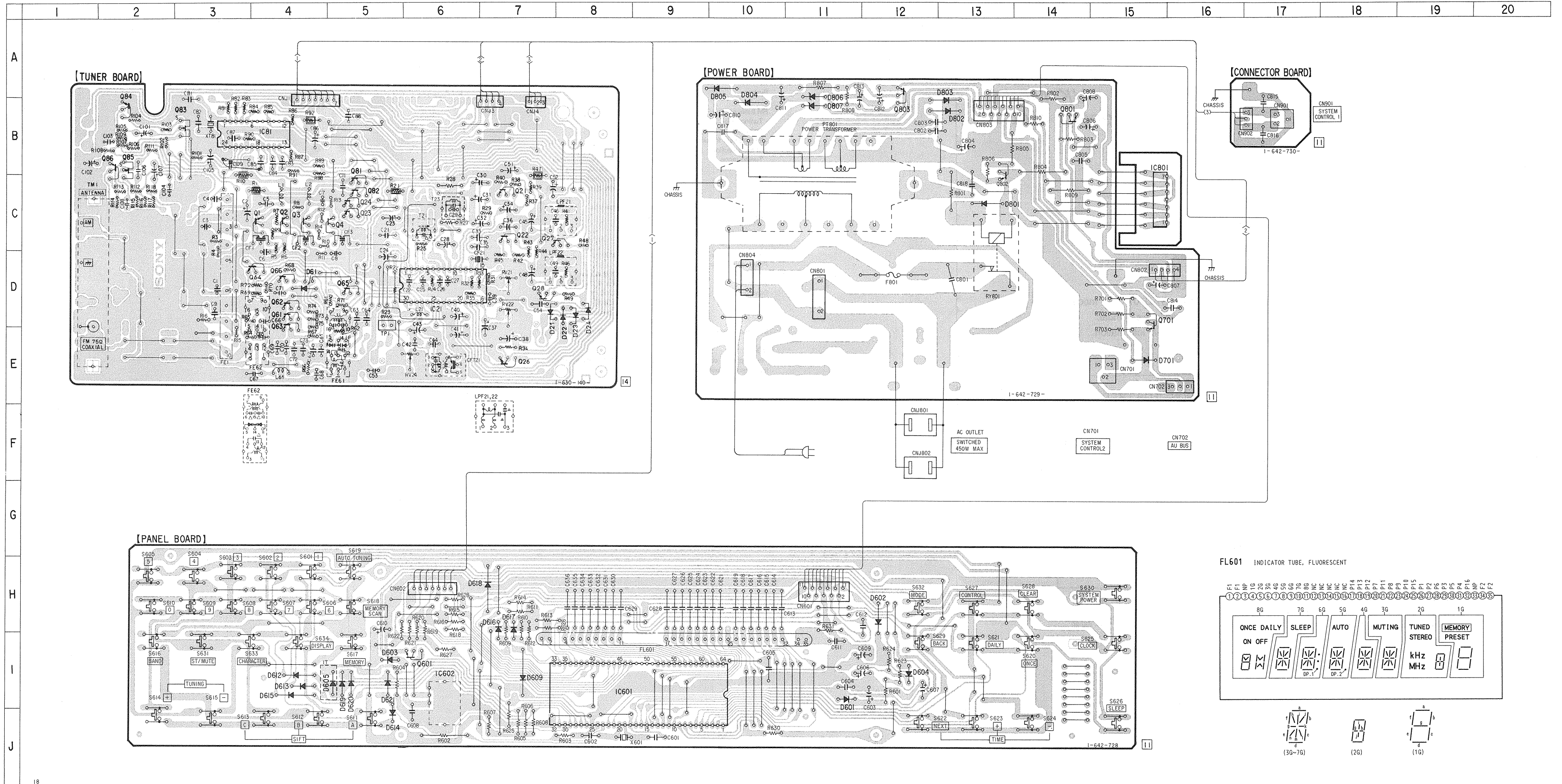



# SECTION 5 ELECTRICAL PARTS LIST

## PANEL    POWER    CONNECTOR

**NOTE:**

- Due to standardization, replacements in the parts list may be different from the parts specified in the diagrams or the components used on the set.
- -XX and -X mean standardized parts, so they may have some difference from the original one.
- RESISTORS  
All resistors are in ohms.  
METAL: Metal-film resistor.  
METAL OXIDE: Metal oxide-film resistor.  
F: nonflammable

- Items marked "\*" are not stocked since they are seldom required for routine service. Some delay should be anticipated when ordering these items.
- SEMICONDUCTORS  
In each case, u:  $\mu$ , for example:  
uA ..:  $\mu$ A..    uPA..:  $\mu$ PA..  
uPB..:  $\mu$ PB..    uPC..:  $\mu$ PC..    uPD..:  $\mu$ PD..
- CAPACITORS  
uF:  $\mu$ F
- COILS  
uH:  $\mu$ H

The components identified by mark  $\Delta$  or dotted line with mark  $\Delta$  are critical for safety. Replace only with part number specified.

When indicating parts by reference number, please include the board.

G: Germany  
IT: Italian

Ref. No.	Part No.	Description	Remark
*	A-4347-295-A	PANEL BOARD, COMPLETE (IT)	
*	A-4347-296-A	PANEL BOARD, COMPLETE (G)	
		*****	
*	A-4347-286-A	POWER BOARD, COMPLETE	
		*****	
		CONNECTOR BOARD	
		*****	
*	4-921-941-01	CUSHION (FL)	
*	4-923-103-01	HOLDER, FL TUBE	
		< CAPACITOR >	
C601	1-162-201-31	CERAMIC    12PF    5%    50V	
C602	1-162-203-31	CERAMIC    15PF    5%    50V	
C603	1-126-163-11	ELECT    4.7uF    20%    50V	
C604	1-164-096-11	CERAMIC    0.01uF    50V	
C605	1-161-379-00	CERAMIC    0.01uF    20%    25V	
C606	1-126-177-11	ELECT    100uF    20%    10V	
C607	1-124-916-11	ELECT    22uF    20%    63V	
C608	1-164-096-11	CERAMIC    0.01uF    50V	
C609	1-126-157-11	ELECT    10uF    20%    16V	
C610	1-126-157-11	ELECT    10uF    20%    16V	
C611	1-164-096-11	CERAMIC    0.01uF    50V	
C612	1-164-096-11	CERAMIC    0.01uF    50V	
C613	1-162-207-31	CERAMIC    22PF    5%    50V	
C614	1-162-207-31	CERAMIC    22PF    5%    50V	
C615	1-162-207-31	CERAMIC    22PF    5%    50V	
C616	1-162-207-31	CERAMIC    22PF    5%    50V	
C617	1-162-207-31	CERAMIC    22PF    5%    50V	
C618	1-162-207-31	CERAMIC    22PF    5%    50V	
C619	1-162-207-31	CERAMIC    22PF    5%    50V	
C621	1-162-207-31	CERAMIC    22PF    5%    50V	
C622	1-162-207-31	CERAMIC    22PF    5%    50V	
C623	1-162-207-31	CERAMIC    22PF    5%    50V	
C624	1-162-207-31	CERAMIC    22PF    5%    50V	
C625	1-162-207-31	CERAMIC    22PF    5%    50V	
C626	1-162-207-31	CERAMIC    22PF    5%    50V	
C627	1-162-207-31	CERAMIC    22PF    5%    50V	
C628	1-162-207-31	CERAMIC    22PF    5%    50V	

Ref. No.	Part No.	Description	Remark
C629	1-162-282-31	CERAMIC    100PF    10%    50V	
C630	1-162-207-31	CERAMIC    22PF    5%    50V	
C631	1-162-207-31	CERAMIC    22PF    5%    50V	
C632	1-162-282-31	CERAMIC    100PF    10%    50V	
C633	1-162-207-31	CERAMIC    22PF    5%    50V	
C634	1-162-282-31	CERAMIC    100PF    10%    50V	
C635	1-162-207-31	CERAMIC    22PF    5%    50V	
C636	1-162-207-31	CERAMIC    22PF    5%    50V	
C801	1-161-744-00	CERAMIC    0.01uF    400V	
C802	1-101-004-00	CERAMIC    0.01uF    50V	
C803	1-101-004-00	CERAMIC    0.01uF    50V	
C804	1-126-105-11	ELECT    1000uF    20%    35V	
C805	1-164-096-11	CERAMIC    0.01uF    50V	
C806	1-126-022-11	ELECT    47uF    20%    16V	
C807	1-126-022-11	ELECT    47uF    20%    16V	
C808	1-126-163-11	ELECT    4.7uF    20%    50V	
C810	1-124-918-11	ELECT    47uF    20%    63V	
C811	1-124-918-11	ELECT    47uF    20%    63V	
C812	1-124-910-11	ELECT    47uF    20%    50V	
C813	1-126-059-11	ELECT    10uF    20%    50V	
C814	1-161-494-00	CERAMIC    0.022uF    25V	
C815	1-164-081-11	CERAMIC    470PF    10%    50V	
C816	1-164-081-11	CERAMIC    470PF    10%    50V	
C817	1-161-379-00	CERAMIC    0.01uF    20%    25V	
C818	1-162-294-31	CERAMIC    0.001uF    10%    50V	
C819	1-161-379-00	CERAMIC    0.01uF    20%    25V	

< CONNECTOR >

* CN601	1-568-854-11	SOCKET, CONNECTOR 11P
* CN602	1-568-273-11	SOCKET, CONNECTOR 7P
* CN701	1-569-625-11	SOCKET, CONNECTOR 3P
* CN702	1-565-561-11	PIN, CONNECTOR 3P
CN801	1-535-139-00	BASE POST 22MM (10MM PITCH) 2P
* CN802	1-568-308-11	SOCKET, CONNECTOR 4P
* CN803	1-568-830-11	SOCKET, CONNECTOR 11P
* CN804	1-564-321-00	PIN, CONNECTOR 2P
* CN901	1-569-625-41	SOCKET, CONNECTOR 3P
CN902	1-568-269-11	SOCKET, CONNECTOR 3P



# PANEL POWER CONNECTOR

Ref. No.	Part No.	Description	Remark
< DIODE >			
D601	8-719-987-63	DIODE 1N4148M	
D602	8-719-987-63	DIODE 1N4148M	
D603	8-719-987-63	DIODE 1N4148M	
D604	8-719-987-63	DIODE 1N4148M	
D605	8-719-987-63	DIODE 1N4148M (IT)	
D609	8-719-987-63	DIODE 1N4148M	
D612	8-719-987-63	DIODE 1N4148M	
D613	8-719-987-63	DIODE 1N4148M	
D614	8-719-987-63	DIODE 1N4148M	
D615	8-719-987-63	DIODE 1N4148M	
D616	8-719-987-63	DIODE 1N4148M	
D617	8-719-987-63	DIODE 1N4148M	
D618	8-719-987-63	DIODE 1N4148M	
D619	8-719-987-63	DIODE 1N4148M	
D620	8-719-987-63	DIODE 1N4148M	
D621	8-719-987-63	DIODE 1N4148M	
D622	8-719-987-63	DIODE 1N4148M	
D701	8-719-987-63	DIODE 1N4148M	
D801	8-719-987-63	DIODE 1N4148M	
D802	8-719-200-77	DIODE 10E2N	
D803	8-719-200-77	DIODE 10E2N	
D804	8-719-200-77	DIODE 10E2N	
D805	8-719-200-77	DIODE 10E2N	
D806	8-719-934-22	LED HZS30-2L	
D807	8-719-014-66	DIODE UZP-5. 6B	
< FUSE HOLDER >			
* FH801	1-533-213-31	HOLDER, FUSE	
* FH802	1-533-213-31	HOLDER, FUSE	
< FILTER >			
FL601	1-519-728-11	INDICATOR TUBE, FLUORESCENT	
< IC >			
IC601	8-759-053-98	IC TMP47C1270N-SOX1029	
IC602	8-741-100-48	IC SBX1610-59	
IC801	8-759-820-09	IC LA5667	
< TRANSFORMER >			
△PT801	1-449-979-11	TRANSFORMER, POWER	
< TRANSISTOR >			
Q601	8-729-900-36	TRANSISTOR DTC124ES	
Q701	8-729-620-05	TRANSISTOR 2SC2603-EF	
Q801	8-729-140-04	TRANSISTOR 2SB1116A-L	
Q802	8-729-620-05	TRANSISTOR 2SC2603-EF	
Q803	8-729-140-04	TRANSISTOR 2SB1116A-L	

Ref. No.	Part No.	Description	Remark
< RESISTOR >			
R601	1-249-441-11	CARBON 100K 5%	1/4W
R602	1-249-429-11	CARBON 10K 5%	1/4W
R603	1-249-441-11	CARBON 100K 5%	1/4W
R604	1-249-441-11	CARBON 100K 5%	1/4W
R605	1-249-429-11	CARBON 10K 5%	1/4W
R606	1-249-429-11	CARBON 10K 5%	1/4W
R607	1-249-429-11	CARBON 10K 5%	1/4W
R608	1-249-429-11	CARBON 10K 5%	1/4W
R609	1-249-429-11	CARBON 10K 5%	1/4W
R610	1-249-429-11	CARBON 10K 5%	1/4W
R611	1-249-429-11	CARBON 10K 5%	1/4W
R612	1-249-429-11	CARBON 10K 5%	1/4W
R613	1-249-425-11	CARBON 4. 7K 5%	1/4W
R614	1-249-429-11	CARBON 10K 5%	1/4W
R615	1-249-429-11	CARBON 10K 5%	1/4W
R616	1-249-423-11	CARBON 3. 3K 5%	1/4W
R618	1-249-417-11	CARBON 1K 5%	1/4W
R619	1-249-429-11	CARBON 10K 5%	1/4W
R620	1-249-429-11	CARBON 10K 5%	1/4W
R621	1-249-429-11	CARBON 10K 5%	1/4W
R622	1-249-429-11	CARBON 10K 5%	1/4W
R623	1-249-405-11	CARBON 100 5%	1/4W
R624	1-249-417-11	CARBON 1K 5%	1/4W
R625	1-249-441-11	CARBON 100K 5%	1/4W
R626	1-249-429-11	CARBON 10K 5%	1/4W
R627	1-249-429-11	CARBON 10K 5%	1/4W
R628	1-249-417-11	CARBON 1K 5%	1/4W
R629	1-249-417-11	CARBON 1K 5%	1/4W
R630	1-249-441-11	CARBON 100K 5%	1/4W
R631	1-249-385-11	CARBON 2. 2 5%	1/6W
R701	1-249-425-11	CARBON 4. 7K 5%	1/4W
R702	1-249-429-11	CARBON 10K 5%	1/4W
R703	1-249-393-11	CARBON 10 5%	1/4W
△R801	1-215-864-00	METAL OXIDE 150 5%	1W F
R802	1-249-429-11	CARBON 10K 5%	1/4W
R803	1-249-425-11	CARBON 4. 7K 5%	1/4W
R804	1-249-425-11	CARBON 4. 7K 5%	1/4W
R805	1-249-417-11	CARBON 1K 5%	1/4W
R806	1-249-433-11	CARBON 22K 5%	1/4W
△R807	1-247-702-11	CARBON 150 5%	1/4W
R808	1-249-425-11	CARBON 4. 7K 5%	1/4W
R809	1-249-437-11	CARBON 47K 5%	1/4W
R810	1-249-417-11	CARBON 1K 5%	1/4W
< RELAY >			
RY801	1-515-617-11	RELAY	

The components identified by mark △ or dotted line with mark. △ are critical for safety. Replace only with part number specified.



**PANEL**

**POWER**

**CONNECTOR**

**TUNER**

Ref. No.	Part No.	Description	Remark
< SWITCH >			
S601	1-554-303-21	SWITCH, TACTILE (1)	
S602	1-554-303-21	SWITCH, TACTILE (2)	
S603	1-554-303-21	SWITCH, TACTILE (3)	
S604	1-554-303-21	SWITCH, TACTILE (4)	
S605	1-554-303-21	SWITCH, TACTILE (5)	
S606	1-554-303-21	SWITCH, TACTILE (6)	
S607	1-554-303-21	SWITCH, TACTILE (7)	
S608	1-554-303-21	SWITCH, TACTILE (8)	
S609	1-554-303-21	SWITCH, TACTILE (9)	
S610	1-554-303-21	SWITCH, TACTILE (0)	
S611	1-554-303-21	SWITCH, TACTILE (SHIFT A)	
S612	1-554-303-21	SWITCH, TACTILE (SHIFT B)	
S613	1-554-303-21	SWITCH, TACTILE (SHIFT C)	
S614	1-554-303-21	SWITCH, TACTILE (TUNING +)	
S615	1-554-303-21	SWITCH, TACTILE (TUNING -)	
S616	1-554-303-21	SWITCH, TACTILE (BAND)	
S617	1-554-303-21	SWITCH, TACTILE (MEMORY)	
S618	1-554-303-21	SWITCH, TACTILE (MEMORY SCAN)	
S619	1-554-303-21	SWITCH, TACTILE (AUTO TUNING)	
S620	1-554-303-21	SWITCH, TACTILE (ONCE)	
S621	1-554-303-21	SWITCH, TACTILE (DAILY)	
S622	1-554-303-21	SWITCH, TACTILE (TIME NEXT)	
S623	1-554-303-21	SWITCH, TACTILE (TIME +)	
S624	1-554-303-21	SWITCH, TACTILE (TIME -)	
S625	1-554-303-21	SWITCH, TACTILE (CLOCK)	
S626	1-554-303-21	SWITCH, TACTILE (SLEEP)	
S627	1-554-303-21	SWITCH, TACTILE (CONTROL)	
S628	1-554-303-21	SWITCH, TACTILE (CLEAR)	
S629	1-554-303-21	SWITCH, TACTILE (BACK)	
S630	1-554-303-21	SWITCH, TACTILE (SYSTEM POWER)	
S631	1-554-303-21	SWITCH, TACTILE (ST/MUTE)	
S632	1-554-303-21	SWITCH, TACTILE (MODE)	
S633	1-554-303-21	SWITCH, TACTILE (CHARACTER)	
S634	1-554-303-21	SWITCH, TACTILE (DISPLAY)	
< VIBRATOR >			
X601	1-579-564-11	VIBRATOR, CRYSTAL (8.389MHz)	
*****			
*	A-4347-289-A	TUNER BOARD, COMPLETE	
*****			
*	4-612-009-01	SPACER (A)	
*	4-923-470-01	PLATE, SHIELD	
*	4-924-988-11	PLATE (ST), GROUND	
*	4-930-855-01	SHEET (2P)	

Ref. No.	Part No.	Description	Remark
< CAPACITOR >			
C1	1-162-294-31	CERAMIC 1000PF 20% 25V	
C2	1-124-477-11	ELECT 47uF 20% 25V	
C3	1-163-059-00	CERAMIC 0.01uF 20% 16V	
C4	1-162-294-31	CERAMIC 1000PF 20% 25V	
C5	1-163-059-00	CERAMIC 0.01uF 20% 16V	
C6	1-163-059-00	CERAMIC 0.01uF 20% 16V	
C7	1-163-059-00	CERAMIC 0.01uF 20% 16V	
C8	1-163-059-00	CERAMIC 0.01uF 20% 16V	
C9	1-163-059-00	CERAMIC 0.01uF 20% 16V	
C11	1-101-005-00	CERAMIC 22000PF 50V	
C21	1-101-006-00	CERAMIC 0.047uF 50V	
C22	1-163-059-00	CERAMIC 0.01uF 20% 16V	
C23	1-124-119-00	ELECT 330uF 20% 16V	
C24	1-123-382-00	ELECT 3.3uF 20% 100V	
C25	1-163-063-00	CERAMIC 22000PF 25V	
C26	1-163-019-00	CERAMIC 6800PF 20% 12V	
C27	1-162-521-11	CERAMIC 680PF 10% 50V	
C28	1-124-903-11	ELECT 1uF 20% 50V	
C29	1-162-516-11	CERAMIC 100PF 10% 50V	
C30	1-124-903-11	ELECT 1uF 20% 50V	
C31	1-124-902-00	ELECT 0.47uF 20% 50V	
C32	1-124-463-00	ELECT 0.1uF 20% 50V	
C33	1-130-481-00	MYLAR 0.0068uF 5% 50V	
C34	1-123-382-00	ELECT 3.3uF 20% 100V	
C35	1-130-481-00	MYLAR 0.0068uF 5% 50V	
C36	1-123-382-00	ELECT 3.3uF 20% 100V	
C37	1-124-907-11	ELECT 10uF 20% 50V	
C38	1-124-907-11	ELECT 10uF 20% 50V	
C39	1-163-059-00	CERAMIC 0.01uF 20% 16V	
C40	1-124-463-00	ELECT 0.1uF 20% 50V	
C41	1-124-927-11	ELECT 4.7uF 20% 100V	
C42	1-163-059-00	CERAMIC 0.01uF 20% 16V	
C43	1-126-176-11	ELECT 220uF 20% 10V	
C44	1-163-059-00	CERAMIC 0.01uF 20% 16V	
C45	1-123-382-00	ELECT 3.3uF 20% 100V	
C46	1-161-375-00	CERAMIC 2200PF 20% 25V	
C48	1-123-382-00	ELECT 3.3uF 20% 100V	
C49	1-161-375-00	CERAMIC 2200PF 20% 25V	
C51	1-124-477-11	ELECT 47uF 20% 25V	
C52	1-124-252-00	ELECT 0.33uF 20% 50V	
C53	1-163-105-00	CERAMIC 33PF 5% 50V	
C54	1-101-005-00	CERAMIC 22000PF 50V	
C61	1-163-063-00	CERAMIC 22000PF 25V	
C62	1-163-063-00	CERAMIC 22000PF 25V	
C63	1-163-063-00	CERAMIC 22000PF 25V	
C64	1-163-063-00	CERAMIC 22000PF 25V	
C65	1-163-063-00	CERAMIC 22000PF 25V	

# TUNER

Ref. No.	Part No.	Description	Remark		
C66	1-163-063-00	CERAMIC	22000PF		25V
C67	1-102-120-00	CERAMIC	0.0018uF	10%	50V
C68	1-163-011-11	CERAMIC	1500PF	20%	25V
C69	1-163-063-00	CERAMIC	22000PF		25V
C70	1-163-063-00	CERAMIC	22000PF		25V
C71	1-163-063-00	CERAMIC	22000PF		25V
C72	1-163-063-00	CERAMIC	22000PF		25V
C73	1-163-063-00	CERAMIC	22000PF		25V
C81	1-102-961-00	CERAMIC	27PF	5%	50V
C82	1-102-961-00	CERAMIC	27PF	5%	50V
C83	1-163-059-00	CERAMIC	0.01uF	20%	16V
C84	1-163-059-00	CERAMIC	0.01uF	20%	16V
C85	1-163-059-00	CERAMIC	0.01uF	20%	16V
C86	1-124-477-11	ELECT	47uF	20%	25V
C87	1-163-059-00	CERAMIC	0.01uF	20%	16V
C88	1-163-059-00	CERAMIC	0.01uF	20%	16V
C101	1-124-925-11	ELECT	2.2uF	20%	100V
C102	1-124-463-00	ELECT	0.1uF	20%	50V
C103	1-163-059-00	CERAMIC	0.01uF	20%	16V
C104	1-163-059-00	CERAMIC	0.01uF	20%	16V
C105	1-124-477-11	ELECT	47uF	20%	25V
C106	1-136-173-00	FILM	0.47uF	5%	50V
C107	1-124-463-00	ELECT	0.1uF	20%	50V
C108	1-163-063-00	CERAMIC	22000PF		25V
C109	1-102-963-00	CERAMIC	33PF	5%	50V
< FILTER >					
CF1	1-567-389-11	FILTER, CERAMIC			
CF2	1-567-389-11	FILTER, CERAMIC			
CF3	1-567-389-11	FILTER, CERAMIC			
CF21	1-577-075-11	OSCILLATOR, CERAMIC			
< COMPOSITION CIRCUIT BLOCK >					
CFT21	1-404-853-11	TRANSFORMER, IF (CERAMIC FILTER)			
< JACK >					
* CNJ1	1-568-273-11	SOCKET, CONNECTOR 7P			
* CNJ3	1-568-308-11	SOCKET, CONNECTOR 4P			
CNJ4	1-568-269-11	SOCKET, CONNECTOR 3P			
< DIODE >					
D21	8-719-987-63	DIODE 1N4148M			
D22	8-719-987-63	DIODE 1N4148M			
D23	8-719-987-63	DIODE 1N4148M			
D24	8-719-987-63	DIODE 1N4148M			
D61	8-719-987-63	DIODE 1N4148M			

Ref. No.	Part No.	Description	Remark		
< FRONTEND >					
FE1	1-463-857-11	FRONT END (FM)			
FE61	1-236-462-11	ENCAPSULATED COMPONENT			
FE62	1-236-463-11	ENCAPSULATED COMPONENT			
< IC >					
IC21	8-759-821-45	IC LA1851N			
IC81	8-759-820-91	IC LC7218			
< COIL >					
L1	1-410-645-31	INDUCTOR			100uH
L2	1-410-645-31	INDUCTOR			100uH
L21	1-407-500-00	INDUCTOR			4.7mH
L61	1-410-525-11	INDUCTOR			220uH
< FILTER >					
LPF21	1-235-164-00	FILTER, LOW PASS			
LPF22	1-235-164-00	FILTER, LOW PASS			
< TRANSISTOR >					
Q1	8-729-230-XX	TRANSISTOR 2SC2669-OY			
Q2	8-729-230-XX	TRANSISTOR 2SC2669-OY			
Q3	8-729-230-XX	TRANSISTOR 2SC2669-OY			
Q4	8-729-230-XX	TRANSISTOR 2SC2669-OY			
Q21	8-729-119-78	TRANSISTOR 2SC2785-HFE			
Q22	8-729-119-78	TRANSISTOR 2SC2785-HFE			
Q23	8-729-900-61	TRANSISTOR DTA114ES			
Q24	8-729-900-80	TRANSISTOR DTC114ES			
Q26	8-729-900-80	TRANSISTOR DTC114ES			
Q27	8-729-620-05	TRANSISTOR 2SC2603-EF			
Q28	8-729-620-05	TRANSISTOR 2SC2603-EF			
Q61	8-729-900-80	TRANSISTOR DTC114ES			
Q62	8-729-900-80	TRANSISTOR DTC114ES			
Q63	8-729-900-80	TRANSISTOR DTC114ES			
Q64	8-729-620-05	TRANSISTOR 2SC2603-EF			
Q65	8-729-119-76	TRANSISTOR 2SA1175-HFE			
Q66	8-729-900-80	TRANSISTOR DTC114ES			
Q81	8-729-900-61	TRANSISTOR DTA114ES			
Q82	8-729-900-80	TRANSISTOR DTC114ES			
Q83	8-729-202-67	TRANSISTOR 2SK246-GR3			
Q84	8-729-230-93	TRANSISTOR 2SC3113-AB			
Q85	8-729-202-67	TRANSISTOR 2SK246-GR3			
Q86	8-729-230-93	TRANSISTOR 2SC3113-AB			
< RESISTOR >					
△R1	1-249-397-11	CARBON	22	5%	1/4W
R3	1-249-329-11	CARBON	330	5%	1/8W
R4	1-249-329-11	CARBON	330	5%	1/8W

The components identified by mark △ or dotted line with mark △ are critical for safety. Replace only with part number specified.

# TUNER

Ref. No.	Part No.	Description	Remark
R5	1-249-329-11	CARBON	330 5% 1/8W
R6	1-249-350-11	CARBON	18K 5% 1/8W
R7	1-249-329-11	CARBON	330 5% 1/8W
R8	1-249-332-11	CARBON	560 5% 1/8W
R9	1-249-352-11	CARBON	27K 5% 1/8W
R10	1-249-329-11	CARBON	330 5% 1/8W
R11	1-249-350-11	CARBON	18K 5% 1/8W
R12	1-249-329-11	CARBON	330 5% 1/8W
R13	1-249-334-11	CARBON	820 5% 1/8W
R14	1-249-352-11	CARBON	27K 5% 1/8W
R15	1-249-347-11	CARBON	10K 5% 1/8W
R16	1-249-343-11	CARBON	4.7K 5% 1/8W
△R21	1-249-404-00	CARBON	82 5% 1/4W
R22	1-249-430-11	CARBON	12K 5% 1/4W
R23	1-249-335-11	CARBON	1K 5% 1/8W
R24	1-249-353-11	CARBON	33K 5% 1/8W
R25	1-249-346-11	CARBON	8.2K 5% 1/8W
R27	1-249-432-11	CARBON	18K 5% 1/4W
R28	1-249-423-11	CARBON	3.3K 5% 1/4W
R29	1-249-347-11	CARBON	10K 5% 1/8W
R31	1-249-331-11	CARBON	470 5% 1/8W
R32	1-249-347-11	CARBON	10K 5% 1/8W
R33	1-249-347-11	CARBON	10K 5% 1/8W
R34	1-249-425-11	CARBON	4.7K 5% 1/4W
R35	1-249-355-11	CARBON	47K 5% 1/8W
R37	1-249-359-11	CARBON	100K 5% 1/8W
R38	1-249-363-11	CARBON	220K 5% 1/8W
R39	1-249-339-11	CARBON	2.2K 5% 1/8W
R40	1-249-338-11	CARBON	1.8K 5% 1/8W
R41	1-249-344-11	CARBON	5.6K 5% 1/8W
R42	1-249-359-11	CARBON	100K 5% 1/8W
R43	1-249-363-11	CARBON	220K 5% 1/8W
R44	1-249-339-11	CARBON	2.2K 5% 1/8W
R45	1-249-338-11	CARBON	1.8K 5% 1/8W
R46	1-249-344-11	CARBON	5.6K 5% 1/8W
△R47	1-249-409-11	CARBON	220 5% 1/4W
R48	1-249-359-11	CARBON	100K 5% 1/8W
R49	1-249-359-11	CARBON	100K 5% 1/8W
R61	1-249-359-11	CARBON	100K 5% 1/8W
R62	1-249-355-11	CARBON	47K 5% 1/8W
R64	1-249-351-11	CARBON	22K 5% 1/8W
R65	1-249-355-11	CARBON	47K 5% 1/8W
R66	1-215-493-00	METAL	1M 5% 1/4W
R67	1-249-359-11	CARBON	100K 5% 1/8W
R68	1-249-352-11	CARBON	27K 5% 1/8W
R69	1-249-351-11	CARBON	22K 5% 1/8W
R70	1-249-331-11	CARBON	470 5% 1/8W
R71	1-249-339-11	CARBON	2.2K 5% 1/8W

Ref. No.	Part No.	Description	Remark
R72	1-249-351-11	CARBON	22K 5% 1/8W
R73	1-249-347-11	CARBON	10K 5% 1/8W
R74	1-249-347-11	CARBON	10K 5% 1/8W
R75	1-249-343-11	CARBON	4.7K 5% 1/8W
R81	1-249-335-11	CARBON	1K 5% 1/8W
R82	1-249-335-11	CARBON	1K 5% 1/8W
R83	1-249-335-11	CARBON	1K 5% 1/8W
R84	1-249-335-11	CARBON	1K 5% 1/8W
R85	1-249-347-11	CARBON	10K 5% 1/8W
R86	1-249-335-11	CARBON	1K 5% 1/8W
R87	1-249-347-11	CARBON	10K 5% 1/8W
R88	1-249-343-11	CARBON	4.7K 5% 1/8W
R89	1-249-335-11	CARBON	1K 5% 1/8W
R90	1-249-343-11	CARBON	4.7K 5% 1/8W
R91	1-249-335-11	CARBON	1K 5% 1/8W
△R92	1-249-401-11	CARBON	47 5% 1/4W
R101	1-249-341-11	CARBON	3.3K 5% 1/8W
R102	1-249-332-11	CARBON	560 5% 1/8W
R103	1-249-335-11	CARBON	1K 5% 1/8W
R104	1-249-328-11	CARBON	270 5% 1/8W
R105	1-249-343-11	CARBON	4.7K 5% 1/8W
R106	1-249-339-11	CARBON	2.2K 5% 1/8W
R107	1-249-343-11	CARBON	4.7K 5% 1/8W
R108	1-249-323-11	CARBON	100 5% 1/8W
R109	1-249-343-11	CARBON	4.7K 5% 1/8W
△R110	1-249-405-11	CARBON	100 5% 1/4W
R111	1-249-341-11	CARBON	3.3K 5% 1/8W
R112	1-249-332-11	CARBON	560 5% 1/8W
R113	1-249-335-11	CARBON	1K 5% 1/8W
R114	1-249-328-11	CARBON	270 5% 1/8W
R115	1-249-351-11	CARBON	22K 5% 1/8W
R116	1-249-339-11	CARBON	2.2K 5% 1/8W
R117	1-249-343-11	CARBON	4.7K 5% 1/8W
R118	1-249-323-11	CARBON	100 5% 1/8W
< VARIABLE RESISTOR >			
RV21	1-241-629-11	RES, ADJ, CARBON	4.7K
RV22	1-241-631-11	RES, ADJ, CARBON	22K
RV24	1-238-019-11	RES, ADJ, CARBON	47K
< TRANSFORMER >			
T21	1-404-807-11	TRANSFORMER, DISCRIMINATOR	
T23	1-236-465-11	ENCAPSULATED COMPONENT	
< TERMINAL >			
* TM1	1-537-138-31	TERMINAL BOARD (ANT)	

The components identified by mark △ or dotted line with mark △ are critical for safety. Replace only with part number specified.

# TUNER

Ref. No.	Part No.	Description	Remark
----------	----------	-------------	--------

< TEST PIN >

\* TP1 1-560-060-00 PIN, CONNECTOR 2P

< VIBRATOR >

XT81 1-577-126-11 VIBRATOR, CRYSTAL (7.2MHz)

\*\*\*\*\*

## MISCELLANEOUS

\*\*\*\*\*

2 1-575-666-11 WIRE, FLAT TYPE (11 CORE)

△10 1-575-651-11 CORD, POWER

△CNJ801 1-526-794-11 OUTLET, AC

△CNJ802 1-526-794-11 OUTLET, AC

△F801 1-532-286-00 FUSE (2.5A)

\*\*\*\*\*

## ACCESSORIES & PACKING MATERIALS

\*\*\*\*\*

4-920-940-01 SHEET (A), PROTECTION

\* 4-929-563-01 CUSHION

\* 4-952-208-01 INDIVIDUAL CARTON (FOR LBT-D507)

\* 4-952-208-11 INDIVIDUAL CARTON (FOR LBT-D707;G)

\* 4-952-209-01 INDIVIDUAL CARTON (FOR LBT-D607)

\*\*\*\*\*

\*\*\*\*\*

## HARDWARE LIST

\*\*\*\*\*

#1 7-685-134-19 SCREW +BTP 2.6X8 TYPE2 N-S

#2 7-621-773-93 SCREW (PANEL 2.6 TP2)

#3 7-685-646-79 SCREW +BVTP 3X8 TYPE2 N-S

#4 7-621-849-00 SCREW (BV/RING)

#5 7-685-647-79 SCREW +BVTP 3X10 TYPE2 N-S

The components identified by  
mark △ or dotted line with mark.  
△ are critical for safety.  
Replace only with part number  
specified.